

INFLATION OF FOLDED DRIVER AND PASSENGER AIRBAGS

A.J. Buijk and C.J.L. Florie

The MacNeal-Schwendler Company B.V

Abstract

The ever increasing requirements for enhanced passenger safety in cars has led to the fitting of airbags to reduce injury in front end impacts. This in turn has produced a need to accurately analyse the behavior of the airbag as it inflates, and the forces on the occupants as they interact with the airbag. Explicit, transient dynamics codes are ideally suited to solving these non-linear, short term events.

In order to realistically simulate airbag-occupant interaction in safety studies, it is often required that the initial folded state of the airbag represents accurately the actual folded state. Even partially unfolded, the airbag does not normally fit in between the position of the occupant and the relevant parts of the vehicle interior.

In MSC/DYTRAN a module has been implemented to compute the transient states of the airbag as it unfolds, taking into account the interaction of the airbag with itself and relevant external parts. The special contact algorithm in MSC/DYTRAN is an upgrade of the existing contact algorithm in MSC/DYNA enabling the complex fold patterns to be dealt with as they occur in the unfolding process.

MSC/DYTRAN includes a variety of ways of analyzing airbag inflation. At its simplest the airbag can be inflated using a simple uniform pressure model, where the pressure depends on the mass inflow and volume of the airbag. A more accurate approach, taking into account the inertia effects of the gas inside the airbag, is the inclusion of gas dynamics through Euler/Membrane interaction. This is verified by comparing passenger bag inflation calculations with experimental pendulum tests.

The occupant interaction is modelled by coupling MSC/DYTRAN with the Crash Victim Simulation program MADYMO.

Introduction

Explicit transient dynamics originated in finite difference codes in the 1960's for the solution of defence related problems. Over the past twenty-five years it has been expanded into the finite element and finite volume technology and the field of applications has broadened significantly.

One of the most recent applications of this technology has been the simulation of the deployment of airbags and the way in which the bag protects the occupant in a crash. With airbags being fitted to increasing number of vehicles in the US and other markets likely to follow, this small specialized application is likely to increase in importance in the future.

Until now, the behavior of a victim under crash loads is studied using multi-body codes like the crash victim simulation code MADYMO [ref 1]. Experimental data, or data from a finite element crash simulation served as input for MADYMO. Since the finite element program MSC/DYTRAN and MADYMO are coupled, the interaction between the victim and the deformable vehicle structure can be taken into account. This is especially of interest when highly deformable structures such as airbags are included.

The analysis of airbags brings its own range of problems. This work focusses on two aspects of the deployment of an airbag.

Firstly, there is the unfolding of the airbag as it starts out from an initially folded geometry. The extent to which the airbag is initially folded determines the computational effort of the deployment, so it may be sufficient to use a four-fold geometry as an acceptable initial configuration of airbag, steering-wheel and occupant.

Then, the effects of the gasdynamics during deployment can be verified by comparison of passenger airbag inflation calculations and corresponding pendulum tests.

Airbag unfolding

The airbag is initially fully folded and wrapped up on the hub of the steering-wheel. The bag is covered by a seal which breaks open after the bag starts to inflate. The generation of the mesh in the initially folded state was performed by MSC/XL. [ref 2].

The unfolding process in the early stage of the inflation involves many contacts between various parts of the bag. Experience has shown that the existing contact algorithms available in both MSC/DYNA and MSC/DYTRAN were unsuitable for such complex behavior.

Substantial improvements have therefore been made to the algorithms so they can cope with this phenomenon. This involved adding algorithms to deal with the contact situations that were not handled correctly before, and also rewriting the algorithms so they ran many times faster than previously.

The airbag is inflated by a uniform internal pressure constituted from the perfect gas law and the law of energy conservation. The gas law states that

$$p = \frac{m R T}{V}$$

where p is the gas pressure, m is the gas mass, R the gas constant, T the gas temperature and V the current volume of the bag. The mass of the inflowing gas is given as a function of time. Leakage through the airbag material and the holes in the airbag is taken into account [ref 3].

Fig. 1 shows the deployment of the bag. Initially the pressure builds up in the folded bag when the cover is still closed. After sufficient pressure, the cover breaks open along a pre-defined line. This releases the bag from the cover and it expands fully.

For acceptable initial configurations it may be sufficient to model the initial folded geometry of the airbag by a four-fold pattern (fig. 2). The folded airbag is mounted on the hub of the steering wheel. Both the hub and dummy occupant are modelled by MADYMO ellipsoids, whereas the rim is a torus boundary prescribed by MSC/DYTRAN.

The airbag and straps are spatially discretized by 2032 triangular membrane constant strain elements.

The time integration proceeds with the central difference method, which requires a limited time step due to CFL stability criterion. The timestep in MADYMO was enforced to be the same. The occupant is modelled as a MADYMO hybrid III model.

The interaction of the airbag membrane elements with the MADYMO ellipsoids is described in [ref 4].

The pressure calculated by the gasbag equation of state is uniformly applied to the inside of the airbag. This was shown to be a realistic approach for the driver-side airbag if the interest lies in the global behavior of the bag [ref 4]. Albeit some damping must be included for stabilisation. The larger volume of the passenger bag, however, does not lend itself to such an approach.

The results of the full calculation are shown in fig 5 for various times. The unfolding process is shown in detail in fig 3. A better view of the contact algorithm is given in fig 4, which shows the bag cut in half.

Thus one looks into the inside of the airbag, where it can be verified that no intersections of airbag membranes occur. Also symmetry with respect to the midplane is preserved very well. Straps are not visualized in the geometry plots. The steering wheel was fixed in space for the purpose of this calculation. At time= 55 msec dummy's lower torso is in contact with the rim. Inflation of the airbag by a uniform pressure tends to introduce unrealistic oscillations and upward motion. This was stabilized by introducing some damping in the membrane elements. In reality the damping probably stems from the stabilizing gas flow, as is indicated in the passenger bag calculations.

Gas dynamics

The most accurate and complex approach is to model the flow and dynamics of the gas during the deployment process. This can be done by using an Eulerian mesh to model the gas, and a superimposed Lagrangian mesh for the airbag. Coupling algorithms between these two effectively models the interaction between the gas and the airbag.

The Lagrangian mesh used to model the membrane elements constitutes a continuously changing wall constraint for the inflowing gas. The gas exerts pressure on the wall which causes it to move. During the motion the airbag gradually releases Eulerian elements to simulate the increase in volume as the bag inflates. This increasing volume becomes occupied by the inflowing gas. The basic equation used to describe the gas motion are conservation of mass, momentum and energy.

The coupling is formulated for large displacements and is updated every timestep as the bag moves through the Eulerian frame. This enables the simulation of the airbag expansion from a virtually zero initial volume to its fully deployed final state.

The experimental setup is sketched in fig 8 and is meant to simulate a mid-position occupant-airbag interaction. This implies that the bag comes into contact with the body during the inflation period. In the test a passenger airbag hits a pendulum during inflation. The airbag was taped in an unfolded state to the backplate and hangs loosely before inflation.

Dimensions and the discretization are shown in fig 7,9. This experiment was previously reported in [ref 4].

The finite element model of the passenger side airbag was first generated in the fully inflated state (fig 9). The airbag and its straps (connecting the front side of the bag with the backside) have been modelled with the triangular constant strain membrane element.

To obtain the initial configuration of the airbag in the undeployed state, a calculation was performed during which the velocity of some points of the front part of the fully inflated bag was prescribed. A total of 1884 elements was used for this model to represent the bag, and 720 volume elements for the Eulerian domain. Fig 10 shows the initial geometry of the airbag, only half the Euler mesh is shown. The pendulum was modelled by three ellipsoids in MADYMO. (Fig 10,11).

The porosity of the bag was not taken into account geometrically but by a reduction of the massflux after 20 milliseconds. This reduction was based on the outflow from gasbag calculations. The outflow stopped after 58 milliseconds.

The velocity vector plots show the predominantly uniaxial flow of the gas during inflation. (fig 12). The impuls exchange between airbag and pendulum occurs between 20 and 45 milliseconds and seems to be completely determined by the direct interaction of sphere and gas jet. The bag is not yet fully deployed, since there is still a global pressure build up in the bag. The evolution of the rotation angle (fig 13) shows better agreement with the experimental measurements than the corresponding calculation of gasbag inflation in ref 5. Latter shows an underestimation of the exchanged impuls. Difference is that a uniform pressure can only push the sphere if enough mass has been introduced in the bag, whereas the gas dynamics can locally build large pressures due to stagnation of the flow.

This makes the exact characteristics of the inflator an important parameter. In later stages (after 60 milliseconds) the bag becomes too big when compared to films of the experiment. This might be due to the neglect of the outflow of gas through the porosity and holes after 58 milliseconds.

The calculation was performed without any damping in the membrane elements, so the deployment was stabilized by the gas flow. Compared to the gasbag calculation in [ref 5] the bag remains in place instead of moving upwards unrealistically.

Summary

The capability of calculating unfolding airbags allows realistic simulation of occupant safety analyses in conjunction with a CVS program like MADYMO.

Inclusion of gas dynamics in airbag inflation modelling allows for more accurate impulse transfer between airbag and occupant than the gasbag approach. Furthermore the gas flow has a stabilizing effect on the deployment of the bag.

References

1. "MADYMO User's Manual 3D (1988)", Version 4.2. TNO Road Vehicles Institute, Department of Injury Protection, Delft, Netherlands.
2. "Mesh Generation for Folded Automobile Airbags using MSX/XL" , M.T. Howe. to be published.
3. "Unfolding of Airbags", DYTRAN AN24, C.J.L Florie, A.J. Buijk
4. "Validation of Coupled Calculations with MADYMO and PISCES AIRBAG" Buijs, Buijk, de Coo and Sauren, Proceedings of the MADYMO User Conference, 1990.
5. "Subcycling in Transient Finite Element Analysis", Buijs, ISBN 90-9003684-9, Thesis Eindhoven University of Technology.

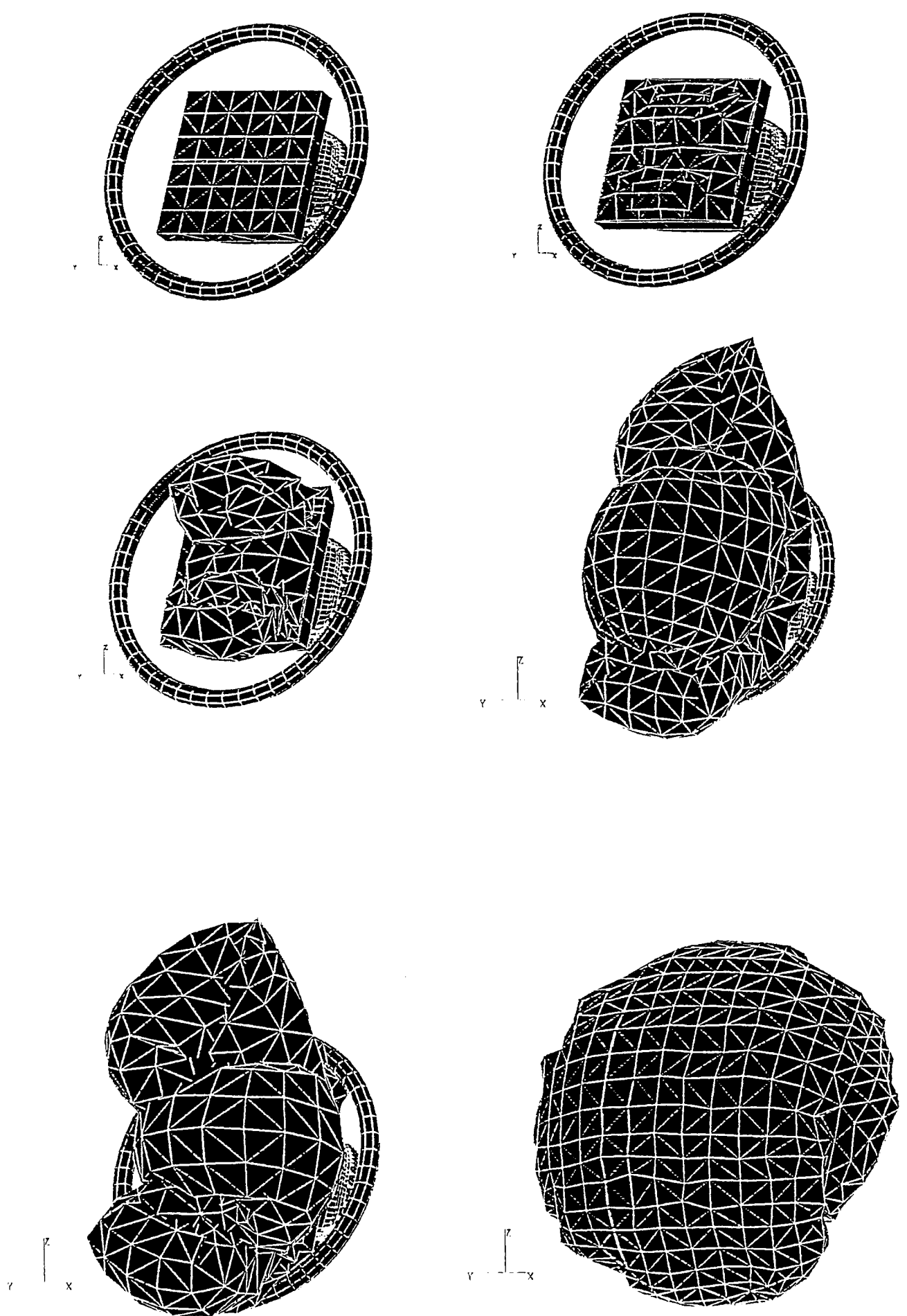

Fig. 1: Deployment of fully covered driver's airbag.

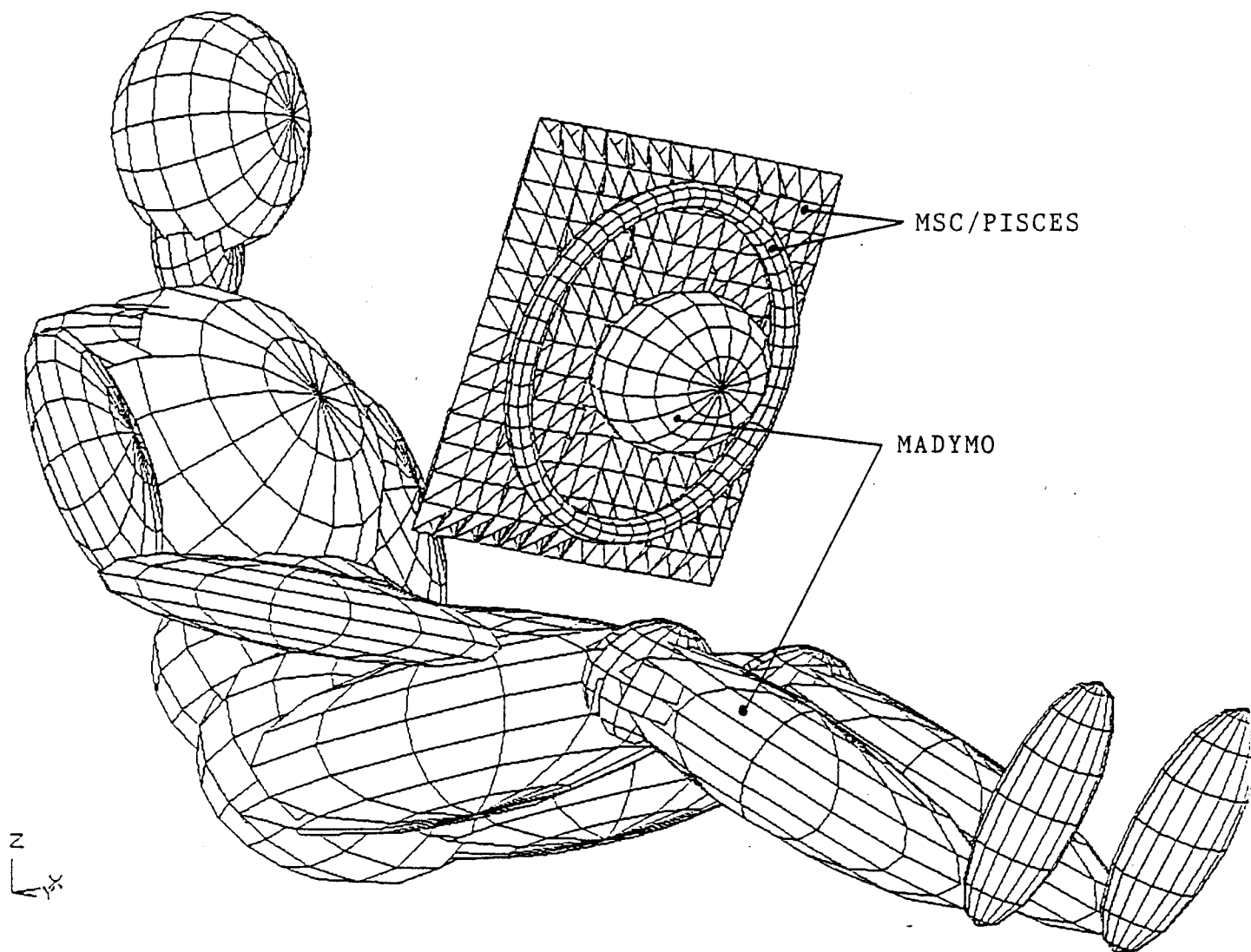
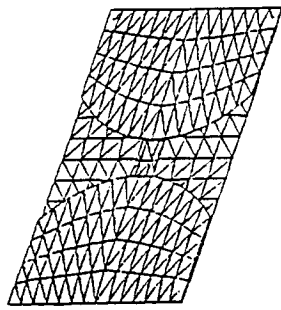
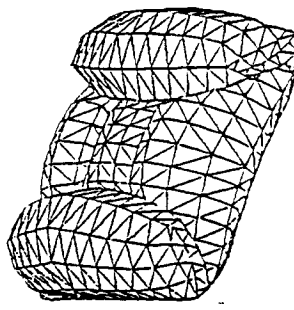

Fig. 2: Configuration of the folded driverside airbag with hybrid III dummy.



Time = 0. msec



Time = 10 msec

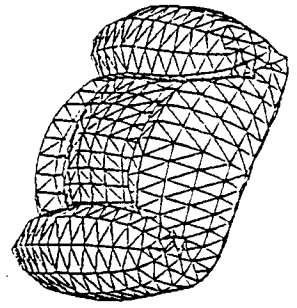

Time = 15 msec

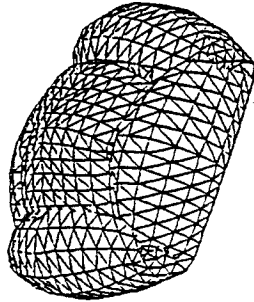

Time = 20 msec

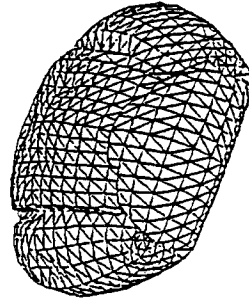

Time = 25 msec

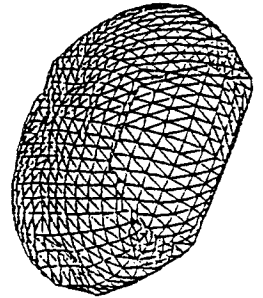

Time = 30 msec

Fig. 3: Unfolding of driverside airbag.

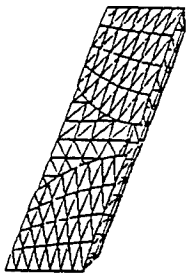

Time = 0 msec

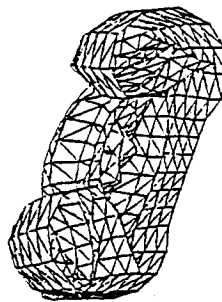

Time = 10 msec

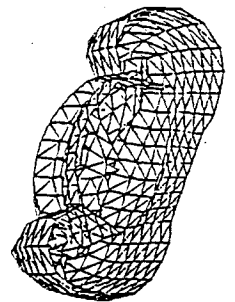

Time = 15 msec

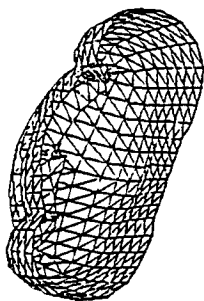

Time = 20 msec

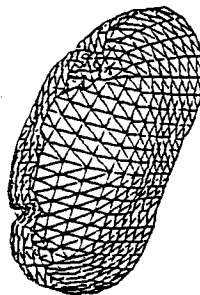

Time = 25 msec

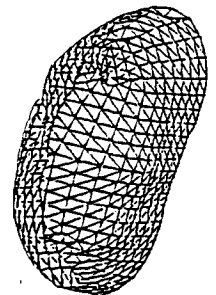

Time = 30 msec

Fig. 4: Unfolding of driverside airbag.
(Bag cut in half)

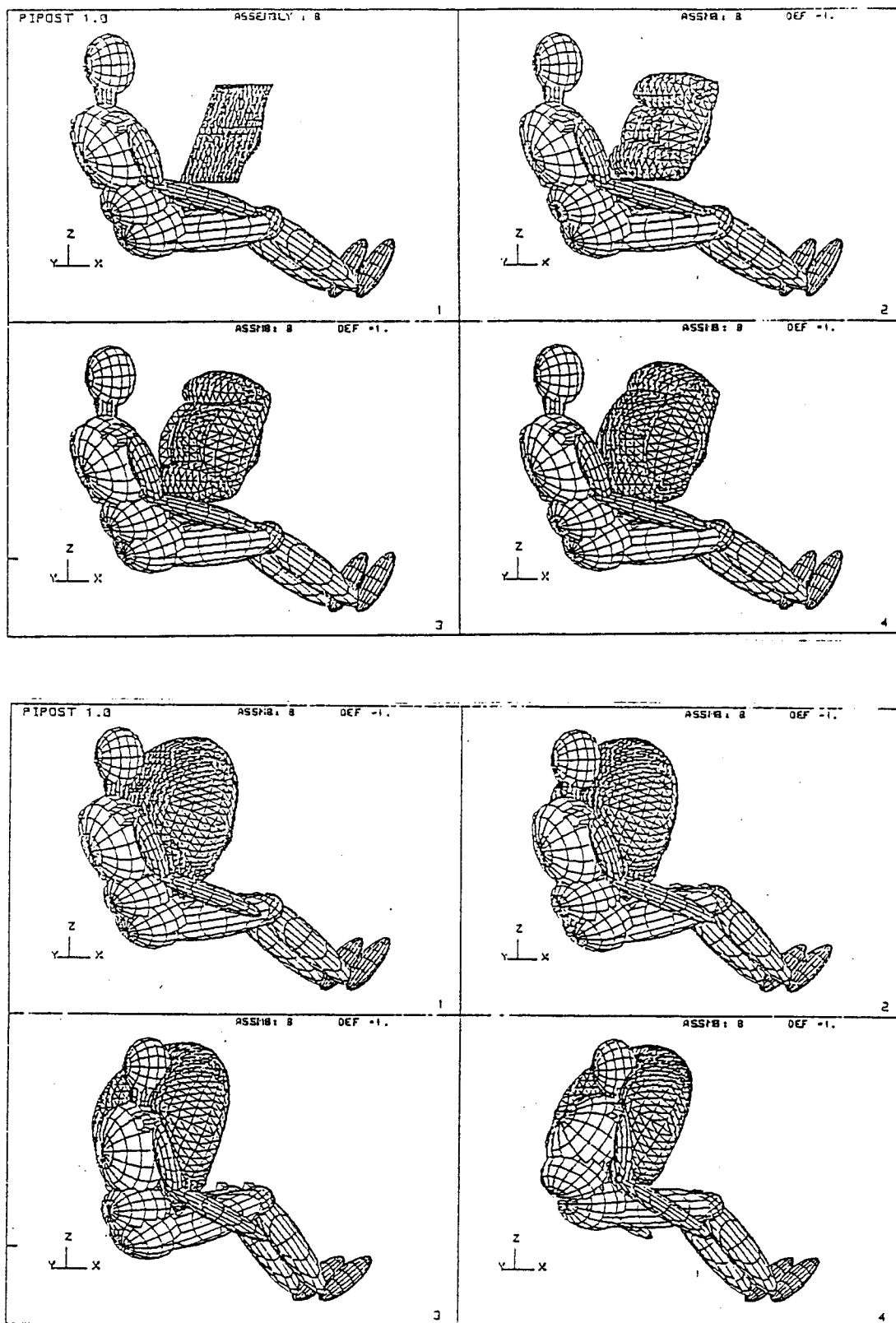

Fig. 5: Interaction of unfolding driver-side airbag with dummy.
 (Times: 0, 10, 15, 20, 55, 70, 80, 90 msec)

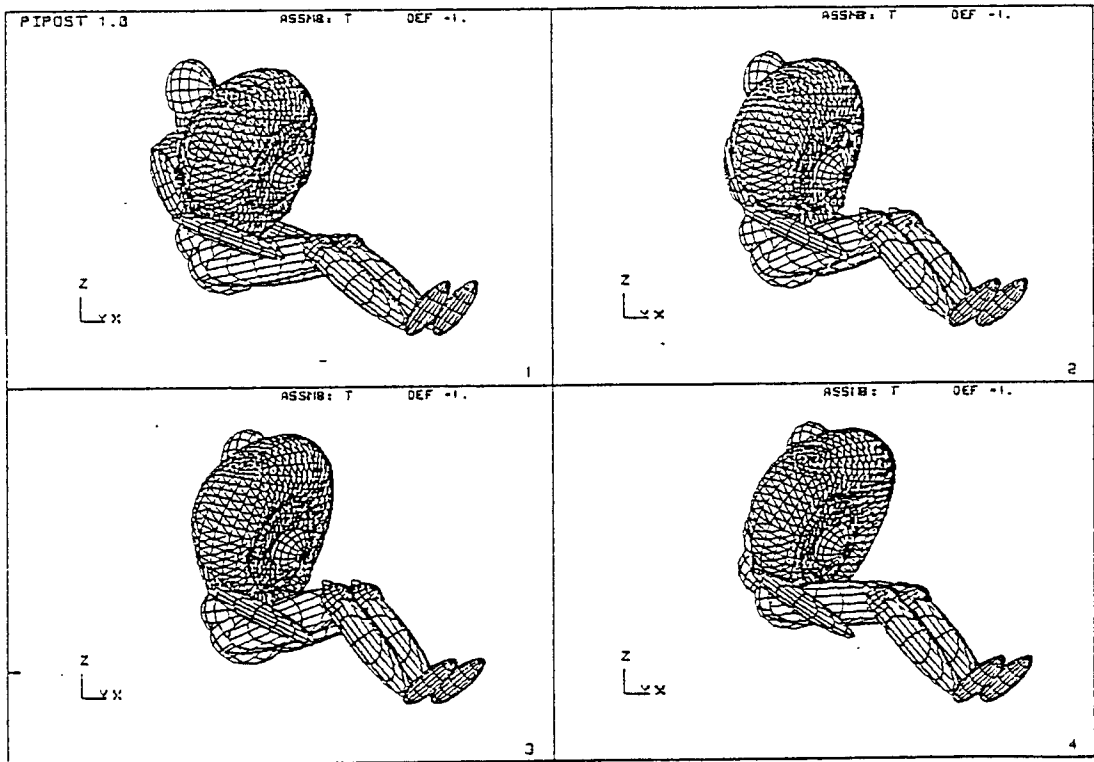
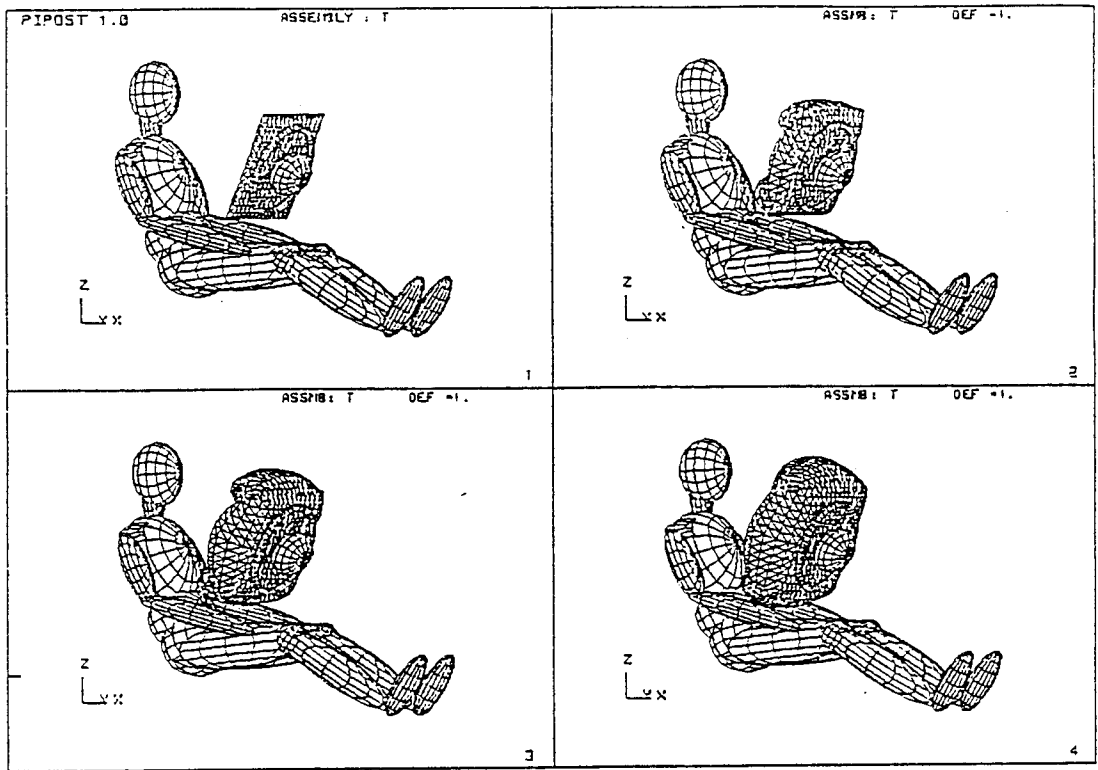
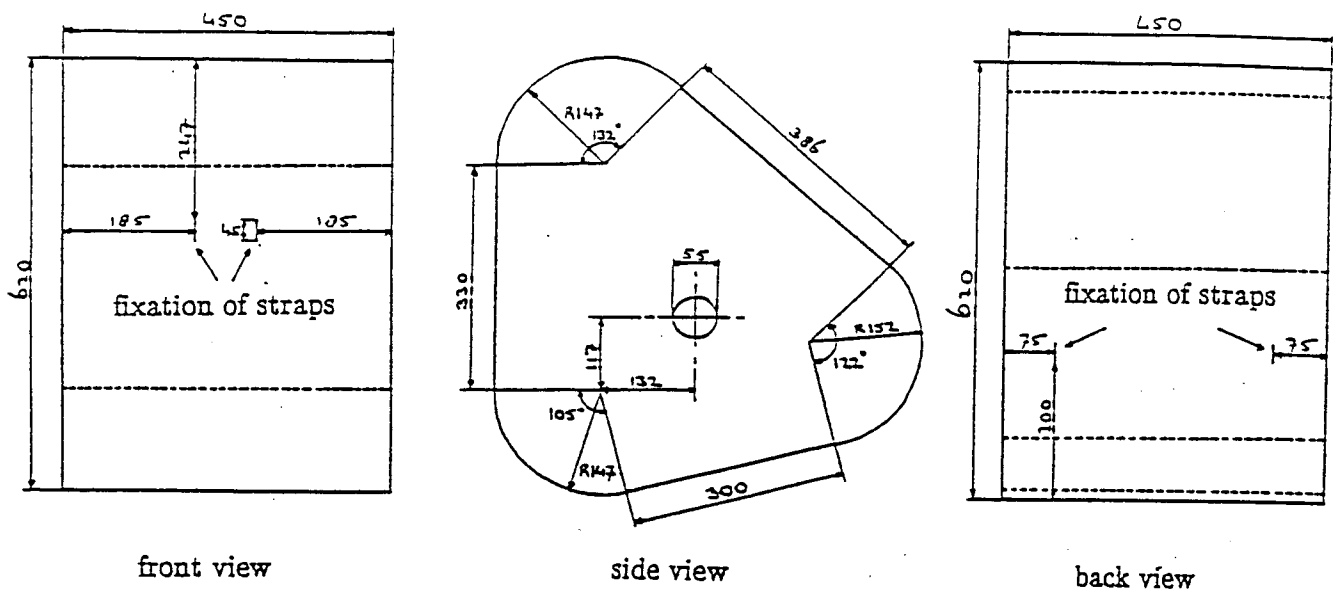

Fig. 6: Interaction of unfolding driverside airbag with dummy.
 (Times: 0, 10, 15, 20, 55, 70, 80, 90 msec)



$E = 6.0 \cdot 10^7 \text{ N/m}^2$ $\rho = 691.617 \text{ kg/m}^3$ $\nu = 0.3$ thickness = 0.0005 m

Fig. 7: Dimensions of the inflated passenger airbag.

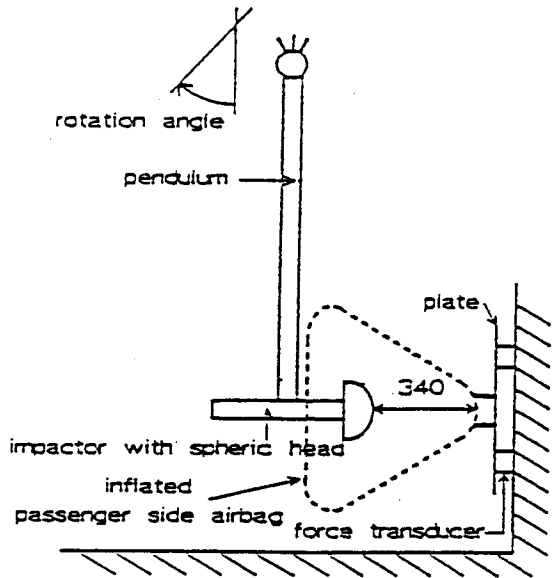

Fig. 8: Experimental setup.

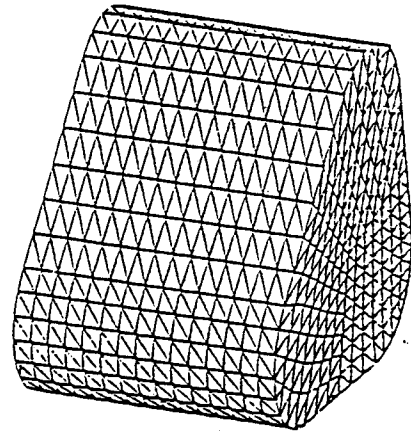

Fig. 9: Discretization of fully deployed airbag.

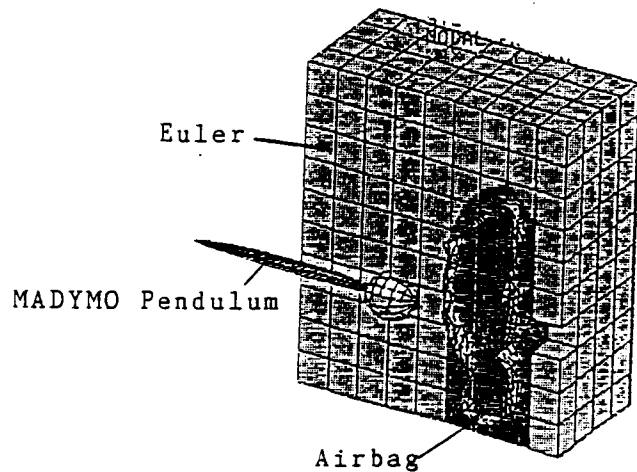

Fig.10: Initial geometry of pendulum, airbag- and Euler-mesh.

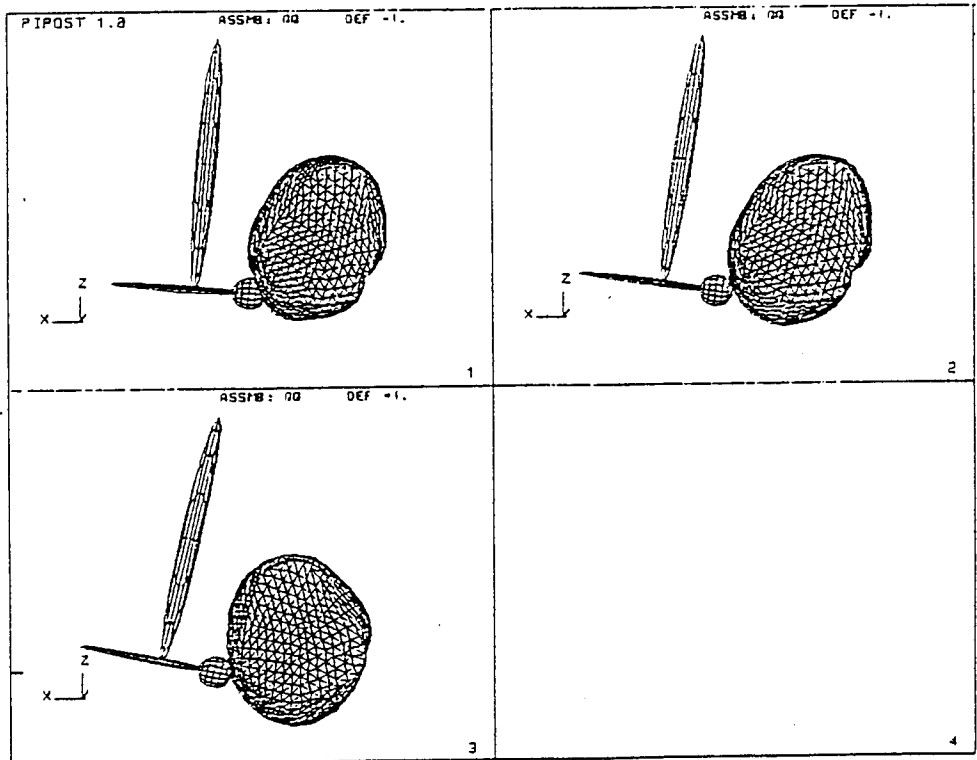
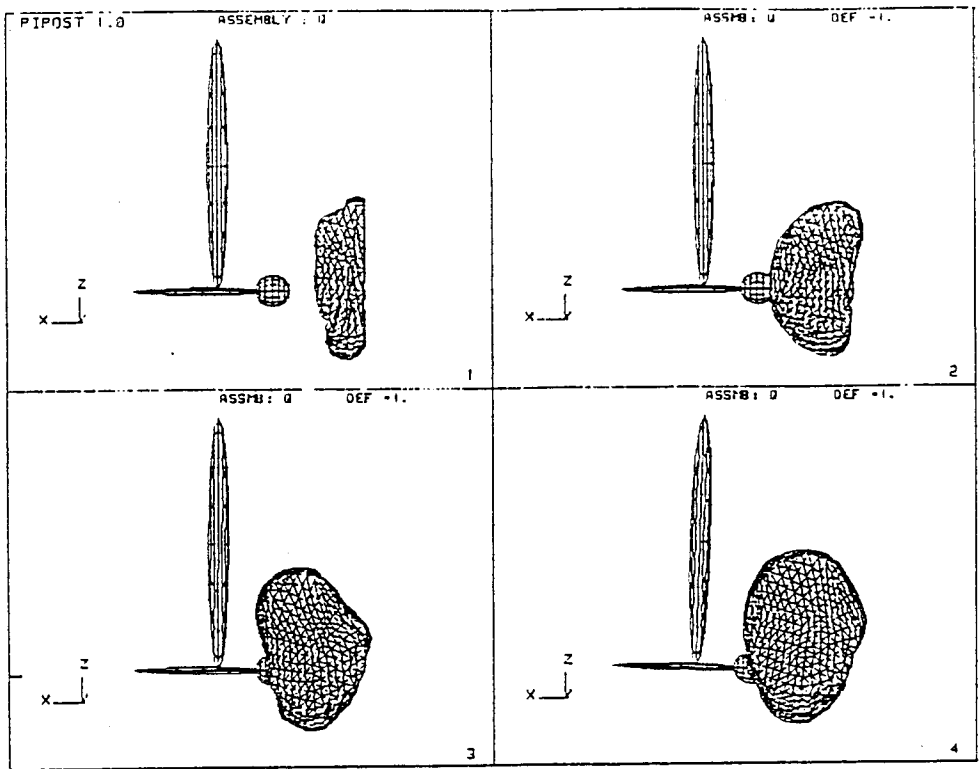

Fig. 11: Sideview of inflating passengerside airbag interacting with pendulum.
 (Time: every 12 msec)

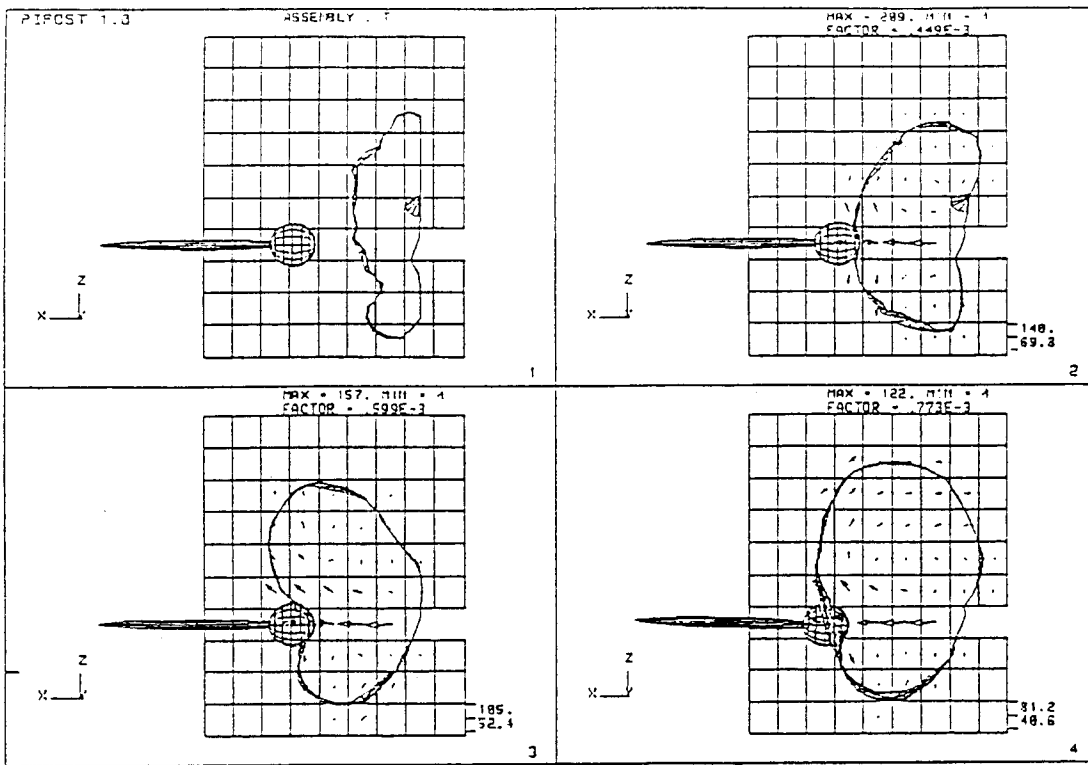

Fig. 12: Velocity vector plots in midplane of inflating passengerside airbag interacting with pendulum. (Time: every 12 msec)

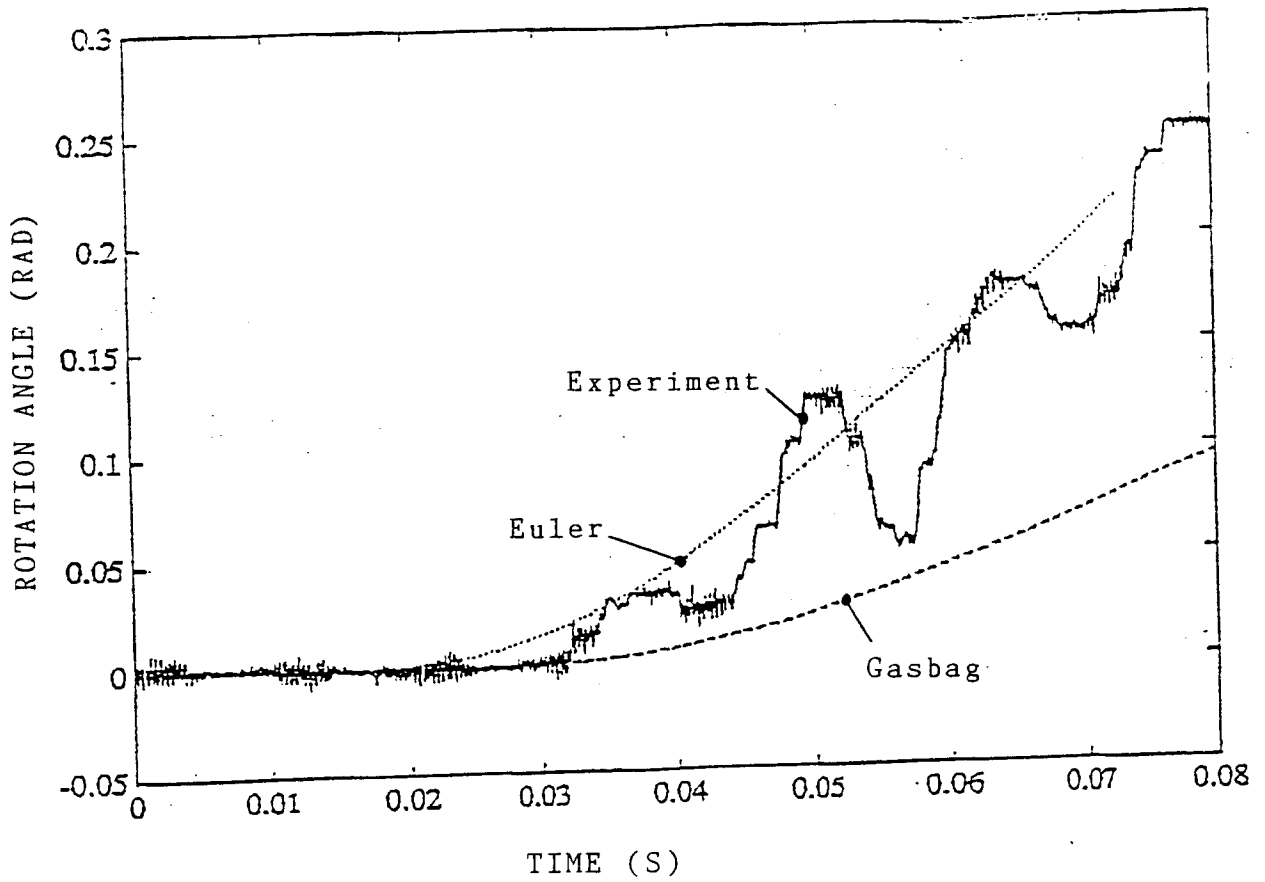

Fig. 13: Rotation angle of pendulum interacting with inflating passengerside airbag

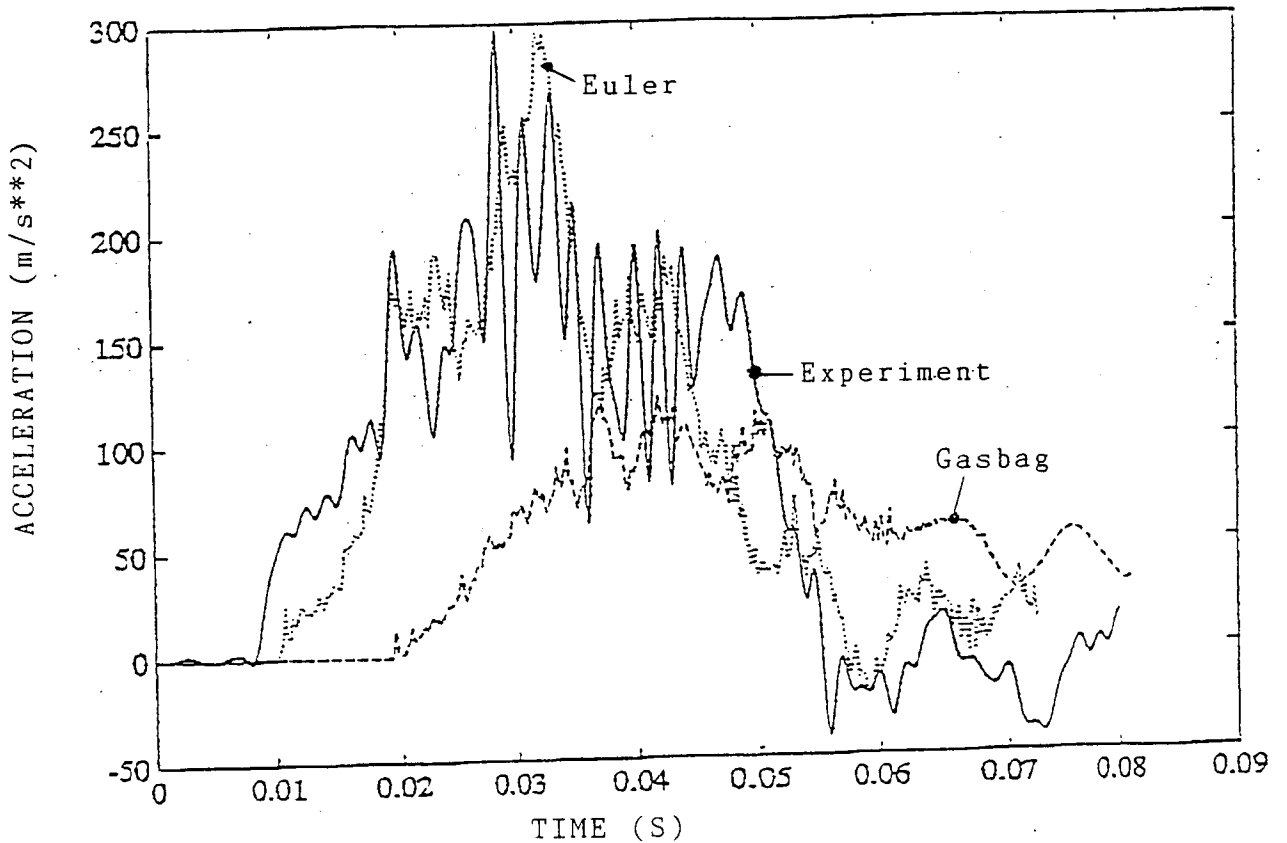

Fig. 14: Acceleration of pendulum interacting with inflating passengerside airbag.